

IL TUBETTO E' IN DOTAZIONE.
TUBE INCLUDED IN THE PACKAGING.
LE TUYAU EST FOURNIT.
DIESES KLEINE ROHR GEHÖRT ZUM LIEFERUMFANG.
EL TUBITO VIENE ENTREGADO EN DOTACION.

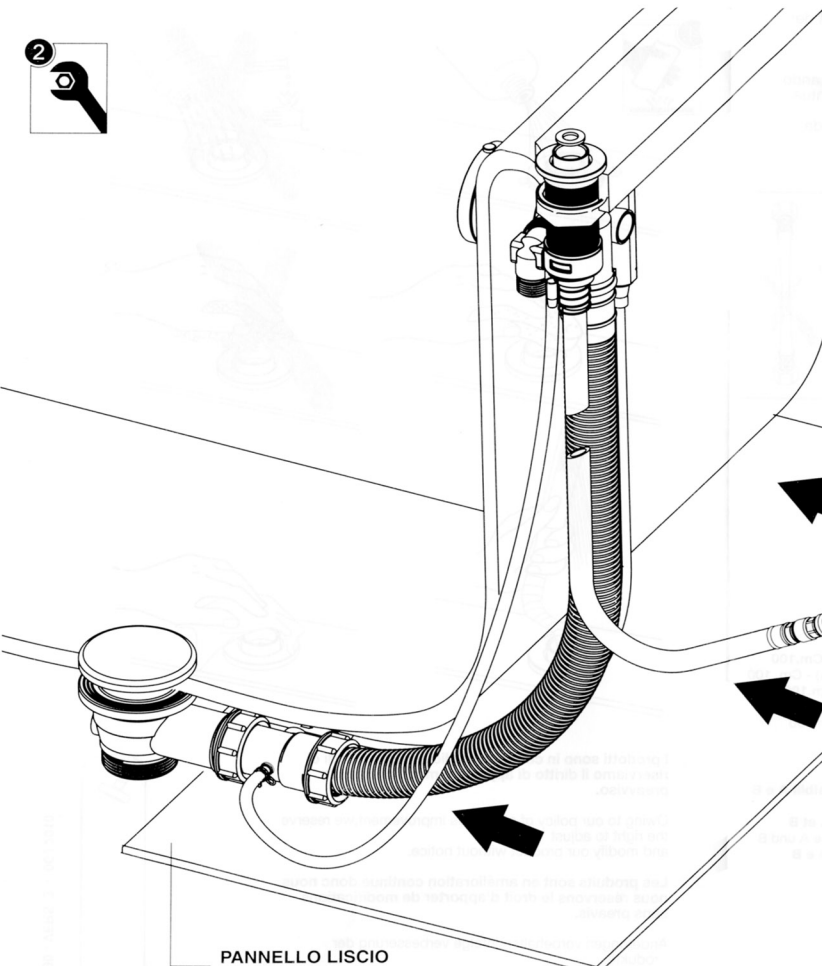
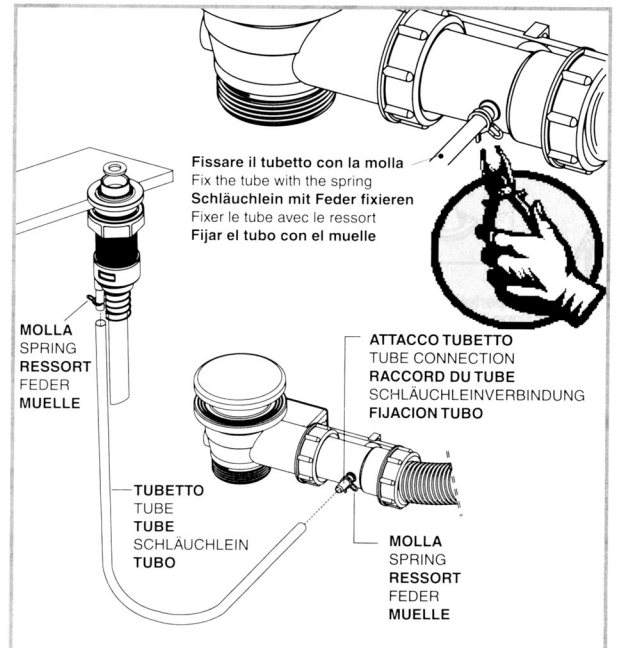
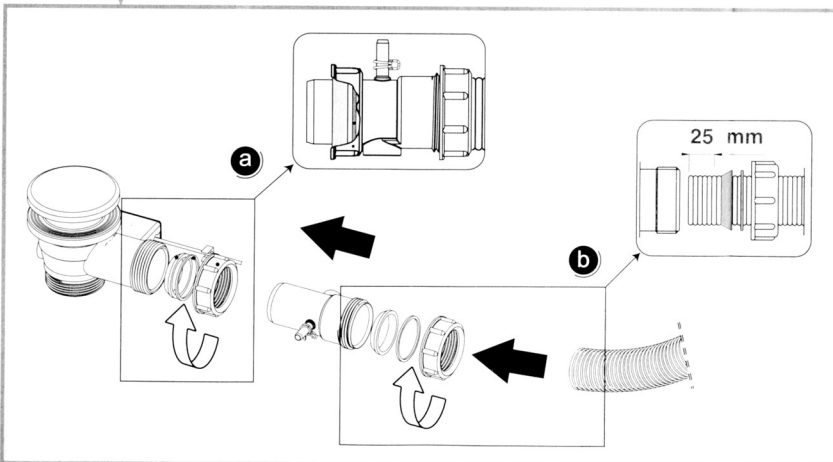

Si si raccomanda di pulire perfettamente la superficie del pavimento al di sotto della vasca, per agevolare il rientro del flessibile completo di molla.
Nel caso in cui il pavimento non sia rivestito da piastrelle, oppure le stesse abbiano superficie ruvida, posizionare un pannello liscio così come raffigurato.

We recomend to perfectly clean the floor surface under the bathtub to facilitate flexible pipe and spring return.
If the floor is not tiled or is covered with coarse tiles, please use a smooth panel as shown in the picture.

Nous recommandons de nettoyer parfaitement le sol dessous la baignoire afin de faciliter le passage du flexible avec le ressort.
Si le sol n'est pas recouvert de carrelage ou que celui-ci ne soit pas lisse, positionner une plaque lisse comme sur le dessin ci-joint.

Wir empfehlen, die Bodenoberfläche unter der Dusche sehr gut zu putzen, um das Schläuchlein komplett mit Feder einfacher wieder legen zu lassen.
Falls es keine Fliesen gibt oder die selbe roh seien sollten, ein glättendes Paneel positionieren, wie im Bild gezeigt.

Se recomienda pulir perfectamente la superficie del pavimento situado bajo la bañera, para facilitar la recuperación del flexible completo del muelle.
En el caso que el pavimento esté revestido en azulejo o superficie rugosa, posicionar un panel liso a fin de facilitar el deslizamiento.

PANNELLO LISCIO
SMOOTH PANEL
PLAQUE LISSE
GLÄTTENDES PANEEL
PANEL LISO

3 SOSTITUZIONE FLESSIBILE (A) - FLEXIBLE REPLACEMENT (A)
 REMPLACEMENT DU FLEXIBLE (A) - SCHLAUCHERSATZ (A)
 SUBSTITUCION FLEXIBLE (A)

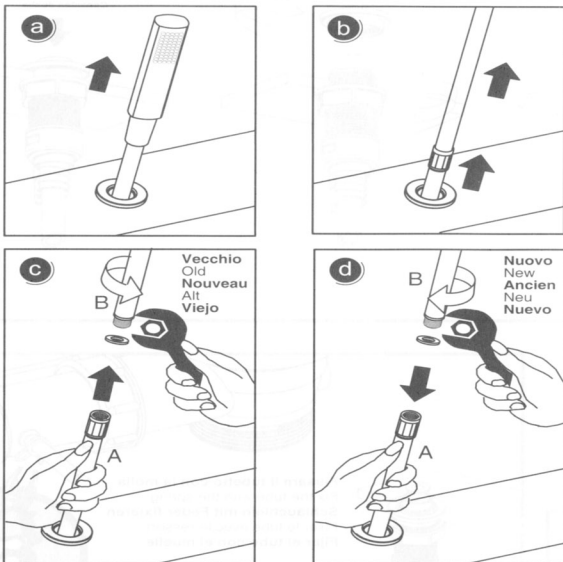

- I** - Avvitare perfettamente il nuovo flessibile al raccordo, con guarnizione interposta, facendo attenzione a non mollare la presa del flessibile (punto A in Fig. C), perché, un suo eventuale rientro al di sotto del bordo vasca, impedirebbe il recupero dello stesso.
 - La distanza dal punto di collegamento di alimentazione al punto di fuoriuscita della doccetta sul bordo vasca, **NON DEVE ESSERE SUPERIORE A 70 Cm.**, in quanto **NON SAREBBE POSSIBILE** sostituire il flessibile B (cm. 150)
- UK** - Tightly screw the new flexible to the connection, with the gasket in between, paying attention not to loose grip on the flexible (point A in picture C), because an incidental recovery below the bath deck mixer will hamper its collection.
 - The distance between the feeding point and the way out of the hand shower on the bath deck, **MUST NOT EXCEED THE LENGTH OF (70 Cm.)** due to the fact that will be **IMPOSSIBLE** substituting flexible B. (150 Cm.)
- F** - Visser parfaitement le nouveau flexible au raccord avec garniture interposée, en prenant soin de ne pas lâcher la prise du flexible (point A figure C) car un éventuel escamotage au-dessous du bord de la baignoire empêcherait de récupérer le flexible.
 - La distance entre le point d'alimentation et la sortie d'eau de la douchette **NE DOIT PAS ETRE SUPERIEUR A 70 Cm** car le flexible B (cm. 150) **NE PEUT ETRE CHANGE.**
- D** - Den neuen Schlauch nach Zwischenlegen der Dichtung ganz auf das Anschlussstück aufschrauben; dabei darauf achten, den Schlauch (Punkt A auf Abb. C) gut festzuhalten, da er, wenn er unter den Wannenrand rutscht, verloren ist.
 - Der Abstand zwischen Anschlusspunkt der Wasserleitung und Ausgangspunkt der Handbrause auf dem Wannenrand, **MUSS NICHT 70 cm ÜBERSCHREITEN**, sonst **WÄRE ES NICHT MÖGLICH**, den Schlauch B auszutauschen (cm 150).
- E** - Atornillar perfectamente el nuevo flexible al tubo, con las juntas adjuntas, prestando atención de no aflojar la presa del flexible (punto A in Fig. C), porqué un eventual reintro debajo del borde de la bañadera, no permitiría recuperarlos.
 - La distancia del punto de conexión de alimentación al punto de agujero de salida de la ducha sobre la bañera, **NO DEBE SUPERAR LOS 70 cm.**
 En cuanto **NO SERÍA POSIBLE** sustituir el flexible B.

4

Collegamento doccetta
 Hand shower connection
Jonction à la douche
 Verbindung Brause
 Conexión ducha

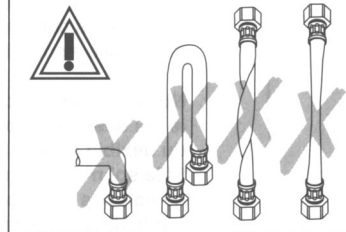
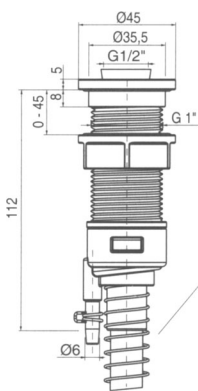

Collegamento di alimentazione
 Feeding connection
Enclenchement d'alimentation
 Versorgungsverbinding
Conexión de alimentación

Flessibile (B) - Cm. 150
 Flexible Hose (B) - Cm. 150
Flexible (B) - Cm. 150
 Schlauch (B) - Cm. 150
 Flexible (B) - Cm. 150



Flessibile (A) - Cm.100
 Flexible Hose (A) - Cm. 100
Flexible (A) - Cm.100
 Schlauch (A) - Cm.100
 Flexible (A) - Cm.100

Raccordo di collegamento dei Flessibili A e B
 Connection flexible hoses A and B
Raccord de jonction des flexibles A et B
 Verbindungsanschlussstück Schläuche A und B
Tubo de conexión de los flexibles A e B

KIT PORTA TUBO
 KIT TUB HOLDER
KIT PORTE TUBE
 ROHRHALTER KIT

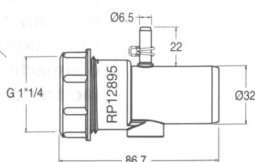
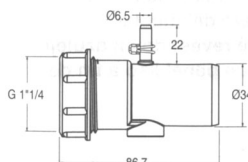

4

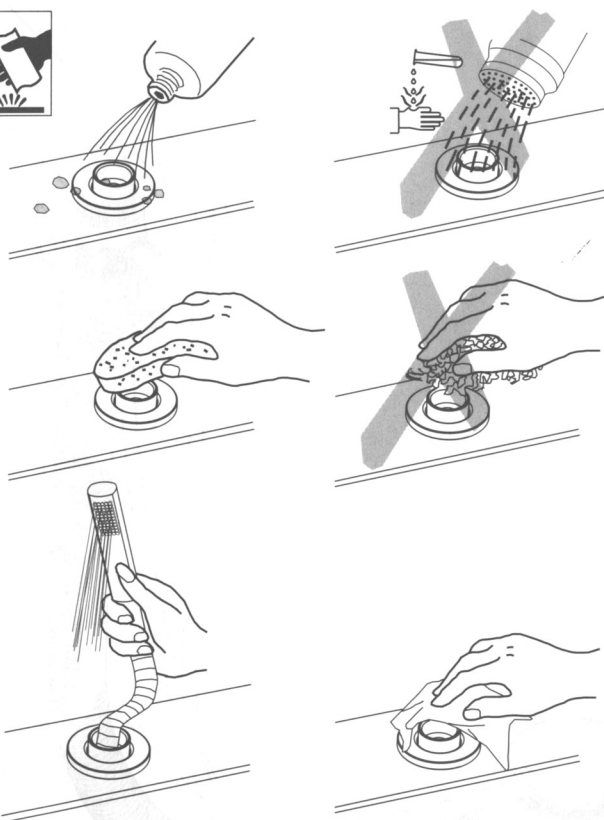

- I** I prodotti sono in continuo miglioramento, quindi ci riserviamo il diritto di apportare modifiche senza preavviso.
- UK** Owing to our policy of continuous improvement, we reserve the right to adjust and modify our product without notice.
- F** Les produits sont en amélioration continue, donc nous réservons le droit d'apporter de modifications sans preavis.
- D** Änderungen vorbehalten infolge verbesserung der produkte.
- E** Los productos estan en continua mejora, por tanto nos reservamos el derecho de aportar modificaciones sin previo aviso.

